

CN

CM2
Ad Specs

Print & digital artwork specifications



Communicating in print & digitally



Contents

CN Magazine

- 1 Advertising
- 2 Inserts
- 3 Bellyband
- 4 Vertical bellyband
- 5 Enhanced bellyband
- 6 Bookmark bellyband
- 7 Bookmark enhanced bellyband
- 8 Front cover fold-out
- 9 Back cover fold-out
- 10 Internal fold-out
- 11 Barndoor
- 12 False cover

nutrition2me.com

- 13 Homepage banners
- 13 Pop-up banner
- 14 Sidebar banners
- 15 Webinars & videos
- 15 CN eXtra
- 15 Diary dates
- 16 Paediatric focus banners
- 17 Digital issue banners

Digital

- 18 CN e-shots
- 19 CN e-news
- 20 Social media sponsorship

Advertising

Double-page spread (DPS):

420 mm (w) x 297 mm (h)*

*(DPS to be supplied as 2 single pdfs)

Full-page (FP):

210 mm (w) x 297 mm (h)

Half-page (HP):

Horizontal:

210 mm (w) x 148 mm (h)

Vertical:

105 mm (w) x 297 mm (h)

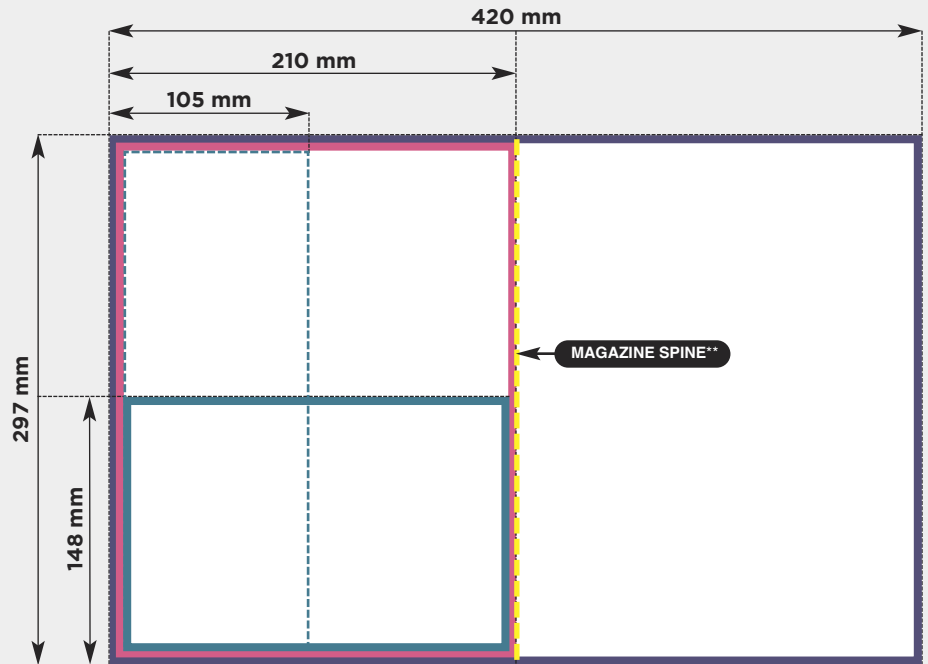

Artwork requirements:

- Artwork size:** *DPS: To be supplied as 2 single FP (2 x 210 mm x 297 mm) • FP & HP: As per dimensions above
- Artwork resolution:** 300 dpi (minimum)
- Artwork file type:** • DPS & FP: Print-ready PDF • HP: EPS or JPEG
- Other requirements:** • 3 mm bleed around all edges • Crop marks • All fonts embedded • CMYK • No spot colours.

****NOTES:** CN Magazine is perfect bound, which means that there is a spine. Following our printer's advice, we advise that you avoid placing text/key information 10 mm (width) either side of the spine.



Product News

Includes: 1 image plus 250 words of text.

Image: To be supplied as a high-resolution JPEG (CMYK) – minimum 300 dpi.

Text: To be supplied within a Word document.



Diary date

Includes: Listing & logo.

Logo: To be supplied as a high-resolution JPEG (CMYK) – minimum 300 dpi.

Text: Event title; linage (event description); date; website; email & tel – to be supplied within a Word document.

Inserts

Loose inserts

Definition

A piece of literature that can be mechanically inserted loosely. Loose inserts need to have straight edges.

Size

Maximum finished size is:
210 mm (w) x 297 mm (h).

Stock weight

Minimum of 115 gsm per leaf.

Acceptable formats

Single leaf (2-page) with or without single fold. Double leaf (4-page) with single leaf.

Hand insert

Definition

A piece of literature that has to be manually inserted (e.g. those with uneven edges/die cut).

Size

Maximum finished size is:
210 mm (w) x 297 mm (h).

Stock weight

No minimum weight.

Acceptable formats

For manual loose insertions we are generally able to accept all literature formats. Please ask for guidance at time of booking.

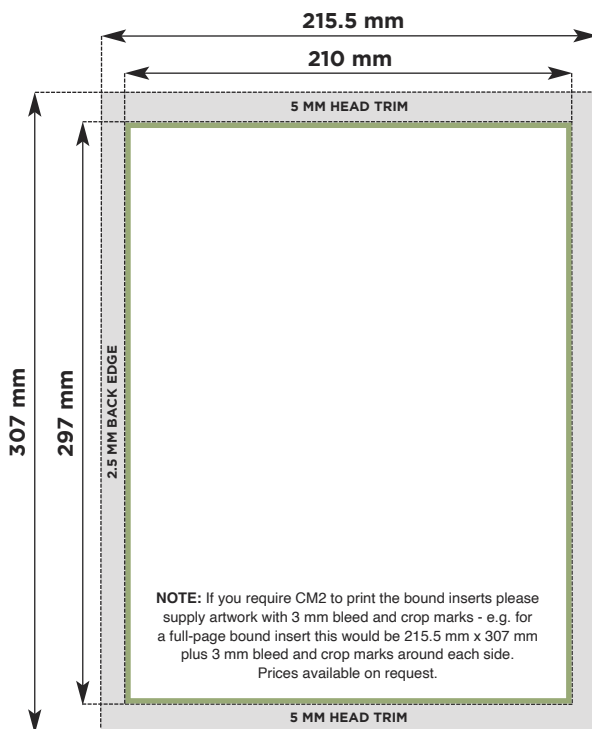
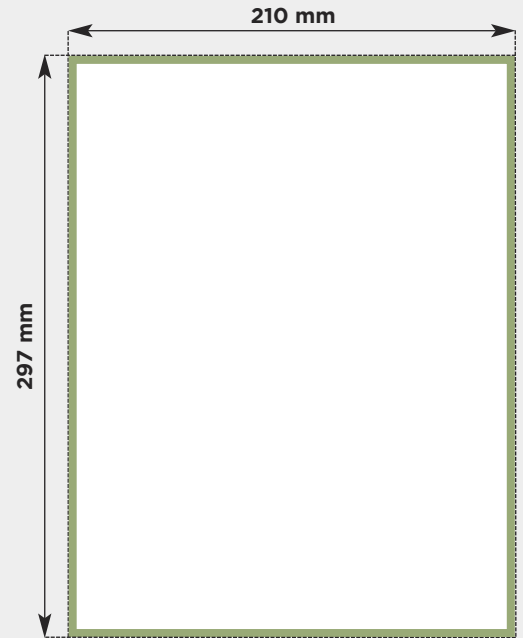

Bound insert

Definition

A piece of literature mechanically bound within the pages of the magazine.

Size

215.5 mm (w) x 307 mm (h) - size of supplied bound inserts for binding into magazine.
210 mm (w) x 297 mm (h) - finished/trimmed size once bound into magazine.

Stock weight

Minimum of 130 gsm, maximum of 250 gsm.

Acceptable formats

Single leaf (2-page) without fold.

Bellyband

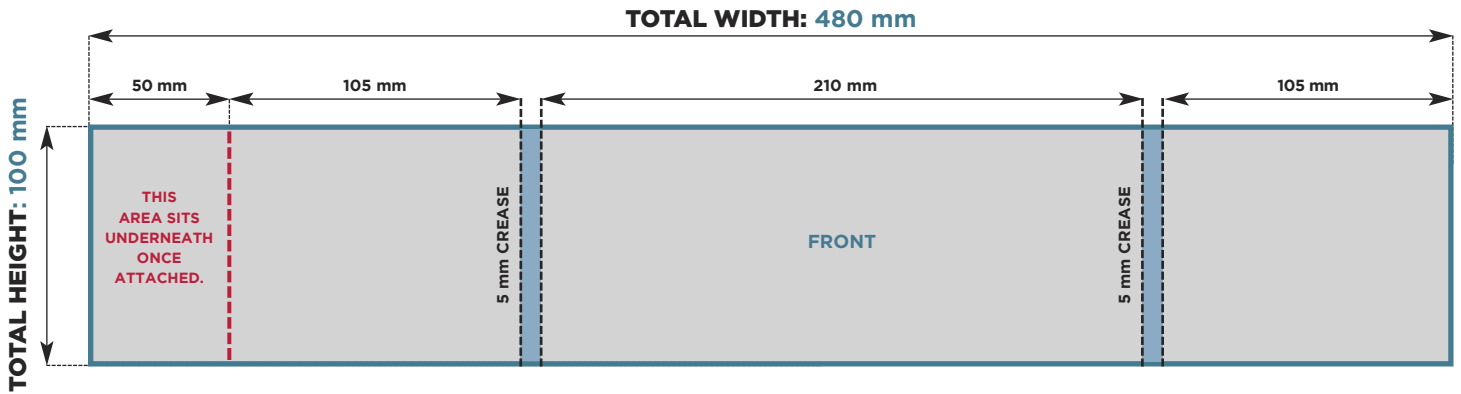

If **we** are printing your bellyband for you

Artwork requirements:

- Artwork size:** 100 mm (h) x 480 mm (w)
- Artwork resolution:** 300 dpi (minimum)
- Artwork file type:** Print-ready PDF
- Other requirements:**
 - 3 mm bleed around all edges
 - Crop marks
 - No spot colours
 - CMYK
 - All fonts embedded.

If **you** are printing & supplying the bellyband

Requirements:

- The size of the finished bellybands supplied should be 100 mm (h) x 480 mm (w)
- The bellybands must be supplied flat, with two creases as indicated in the above image
- We recommend the following print spec: 200 gsm silk, gloss laminate (to prevent cracking when creased)
- Full delivery details and requirements will be supplied to you at the time of booking.

Bellyband visual

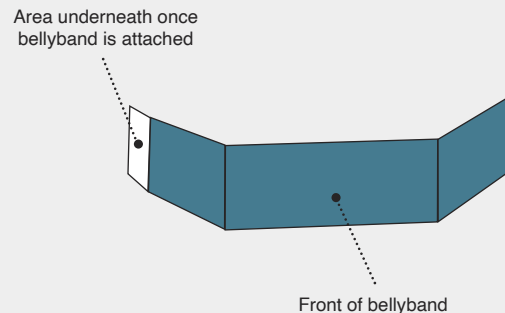
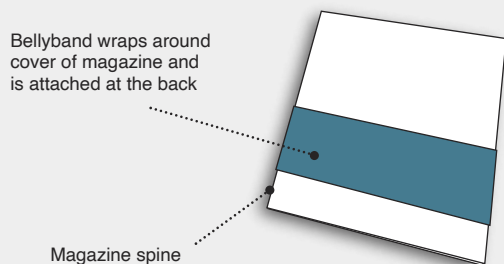

NOTE: Bellybands are attached by hand, please be aware that it is not an exact science!

Vertical bellyband

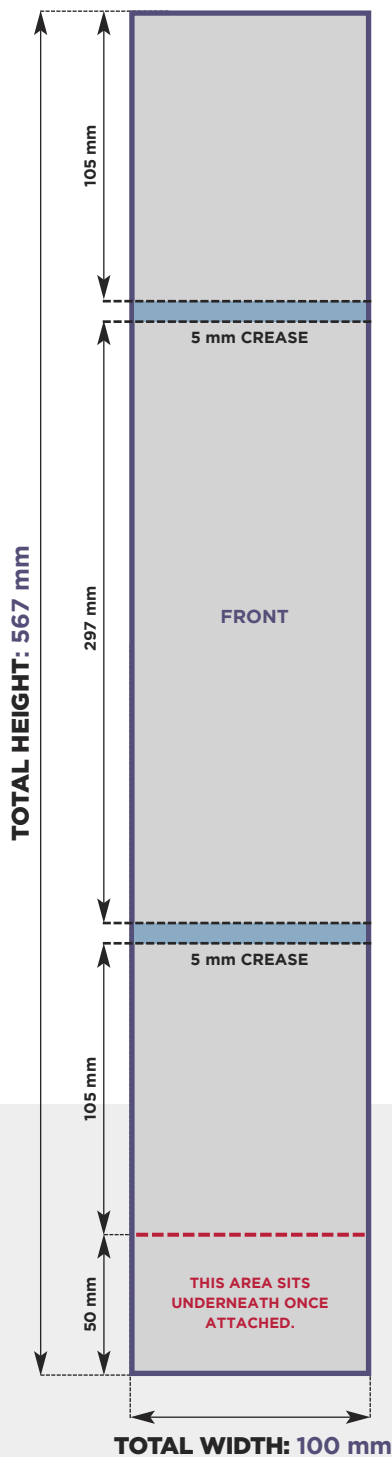

If we are printing your vertical bellyband for you

Artwork requirements:

- Artwork size: 567 mm (h) x 100 mm (w)
- Artwork resolution: 300 dpi (minimum)
- Artwork file type: Print-ready PDF
- Other requirements:
 - 3 mm bleed around all edges
 - Crop marks
 - No spot colours
 - CMYK
 - All fonts embedded.

If you are printing & supplying the vertical bellyband

Requirements:

- The size of the finished bellybands supplied should be: 567 mm (h) x 100 mm (w)
- The bellybands must be supplied flat, with two creases as indicated in the visual to the left
- We recommend the following print spec: 200 gsm silk, gloss laminate (to prevent cracking when creased)
- Full delivery details and requirements will be supplied to you at the time of booking.

Vertical bellyband visual

Bellyband wraps around cover of magazine and is attached at the back

Magazine spine

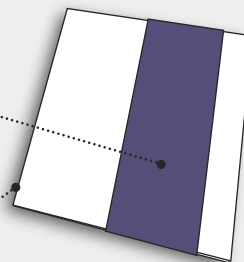

Front of bellyband

Area underneath once bellyband is attached



NOTE: Bellybands are attached by hand, please be aware that it is not an exact science!

Enhanced bellyband

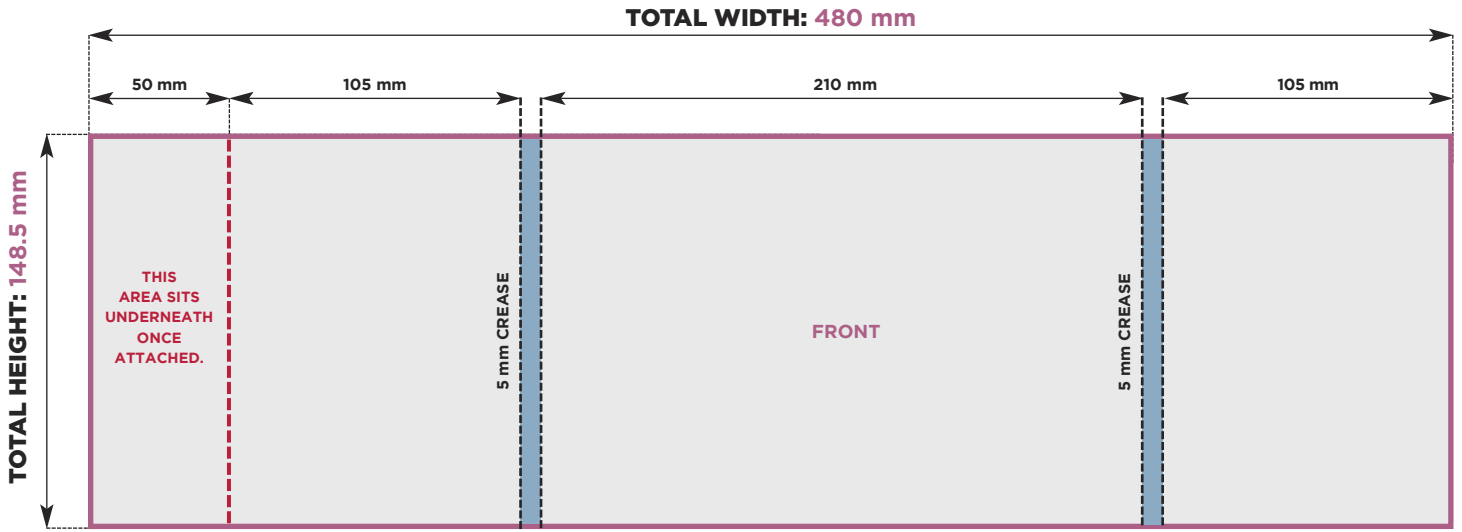

If we are printing your enhanced bellyband for you

Artwork requirements:

- Artwork size: 148.5 mm (h) x 480 mm (w)
- Artwork resolution: 300 dpi (minimum)
- Artwork file type: Print-ready PDF
- Other requirements:
 - 3 mm bleed around all edges
 - Crop marks • No spot colours
 - CMYK • All fonts embedded.

If you are printing & supplying the enhanced bellyband

Requirements:

- The size of the finished bellybands supplied should be: 148.5 mm (h) x 480 mm (w)
- The bellybands must be supplied flat, with two creases as indicated in the above image
- We recommend the following print spec: 200 gsm silk, gloss laminate (to prevent cracking when creased)
- Full delivery details and requirements will be supplied to you at the time of booking.

Enhanced bellyband visual

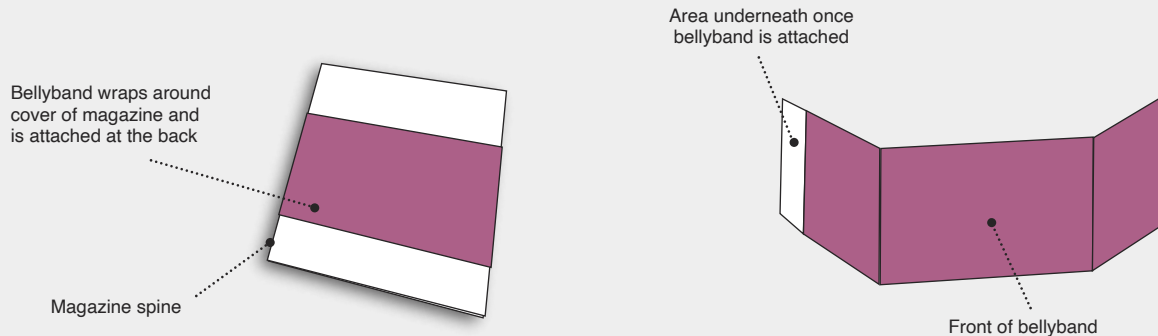

NOTE: Bellybands are attached by hand, please be aware that it is not an exact science!

Bookmark bellyband

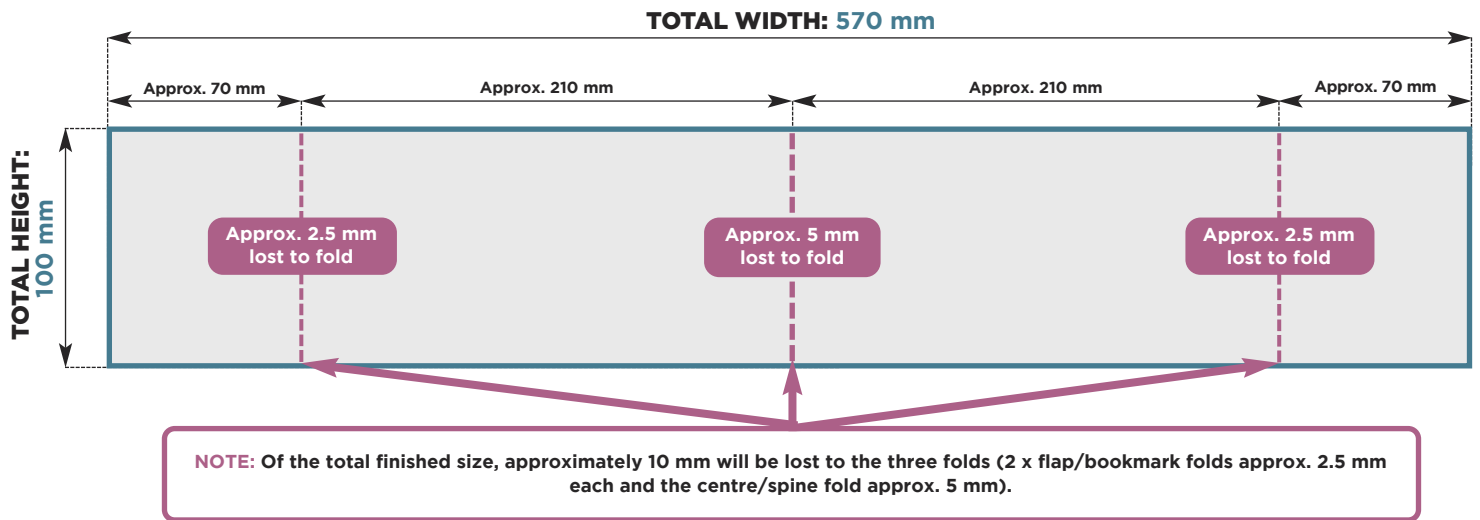

If **we** are printing your bookmark bellyband for you

Artwork requirements:

- Artwork size: 100 mm (h) x 570 mm (w)
- Artwork resolution: 300 dpi (minimum)
- Artwork file type: Print-ready PDF
- Other requirements:
 - 3 mm bleed around all edges
 - Crop marks
 - No spot colours
 - CMYK
 - All fonts embedded.

If **you** are printing & supplying the bookmark bellyband

Requirements:

- The size of the finished bookmark bellybands supplied should be: 100 mm (h) x 570 mm (w)
- The bookmark bellybands must be supplied flat, with a crease down the centre only
- We recommend the following print spec: 200 gsm silk, gloss laminate (to prevent cracking), crease (centre only)
- Full delivery details and requirements will be supplied to you at the time of booking.

Bookmark bellyband visual

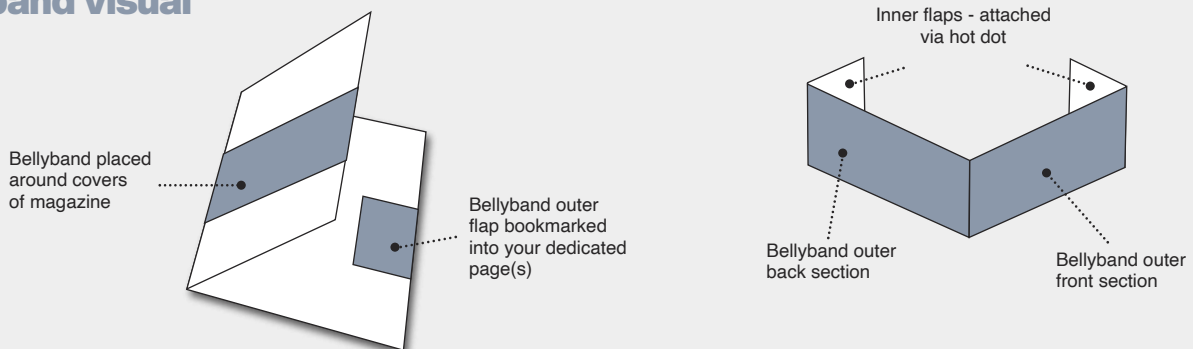

NOTE: Bellybands are attached by hand, please be aware that it is not an exact science!

Enhanced bookmark bellyband

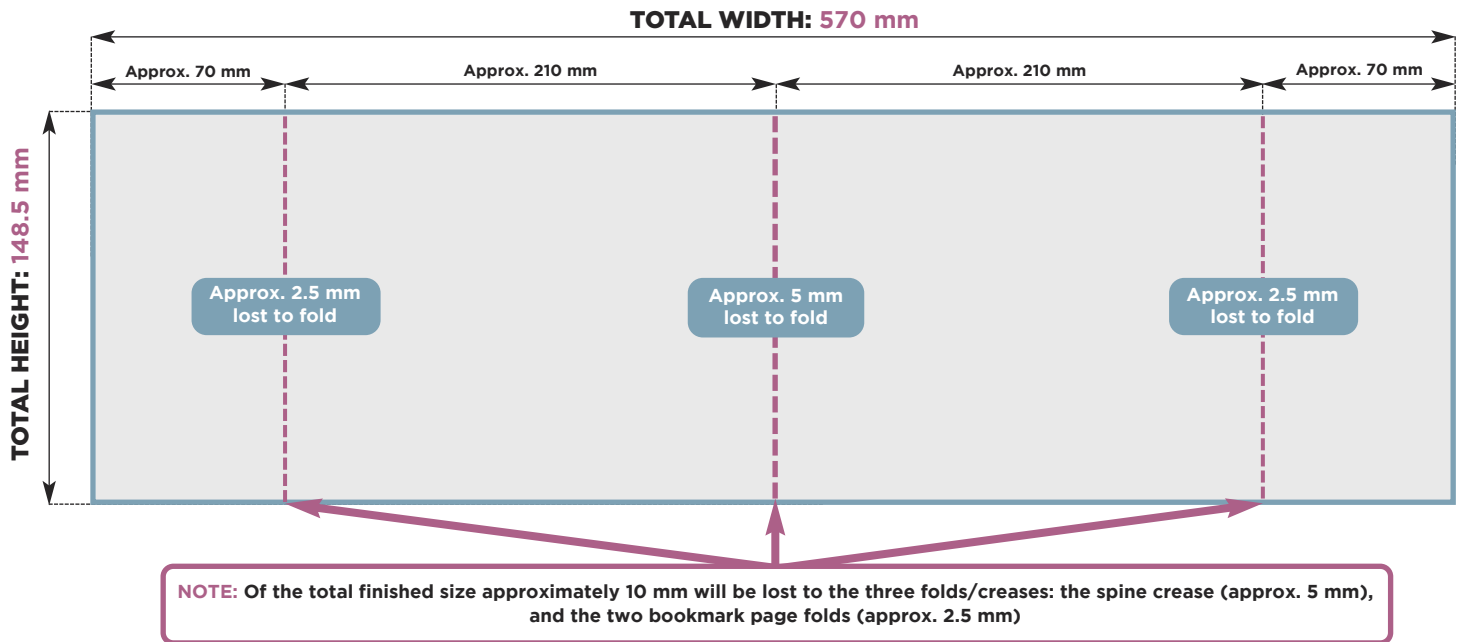

If we are printing your ENHANCED bookmark bellyband for you

Artwork requirements:

- Artwork size:** 148.5 mm (h) x 570 mm (w)
- Artwork resolution:** 300 dpi (minimum)
- Artwork file type:** Print-ready PDF
- Other requirements:**
 - 3 mm bleed around all edges
 - Crop marks • No SPOT colours
 - CMYK • All fonts embedded.

If you are printing & supplying the ENHANCED bookmark bellyband

Requirements:

- The size of the finished bookmark bellybands supplied should be: 148.5 mm (h) x 570 mm (w)
- The bookmark bellybands must be supplied flat, with a crease down the centre only
- We recommend the following print spec: 200 gsm silk, gloss laminate (to prevent cracking), crease (centre only)
- Full delivery details and requirements will be supplied to you at the time of booking.

Enhanced bookmark bellyband visual

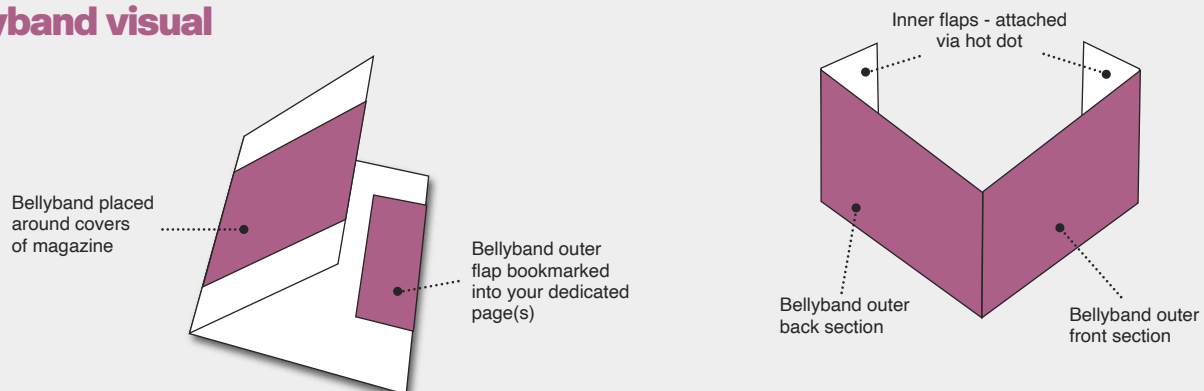

NOTE: Bellybands are attached by hand, please be aware that it is not an exact science!

Front cover **fold-out** (3-pages)

Outside front fold-out (OFF) & inside front fold-out (IFF)
 199 mm (w)
 x 297 mm (h)*

Inside front cover (IFC)
 209 mm (w)
 x 297 mm (h)

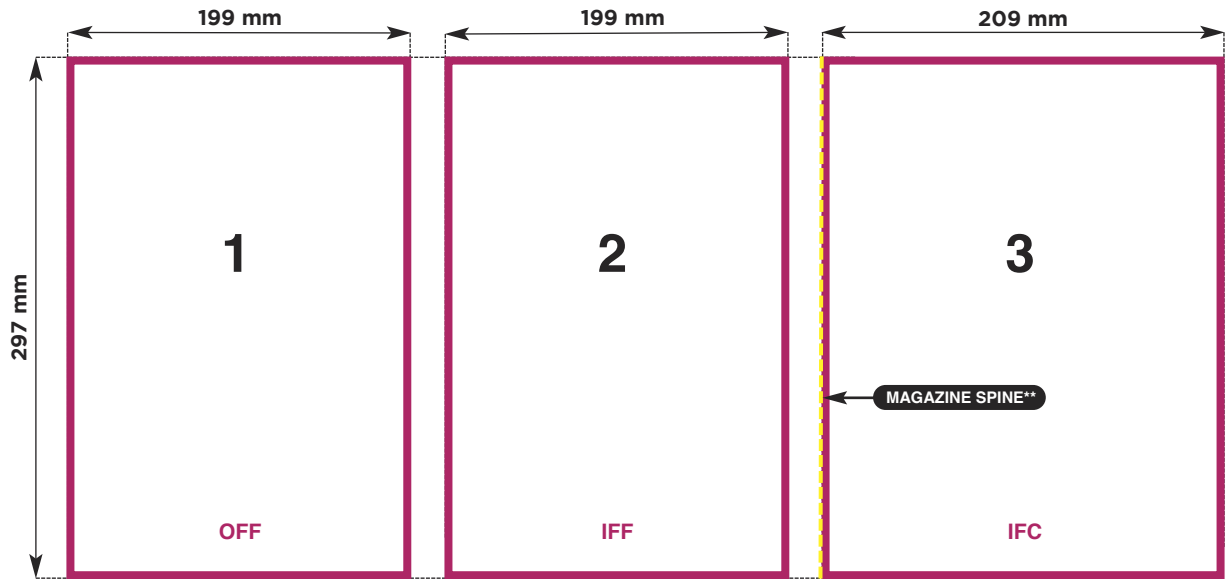

Artwork requirements:

- Artwork size:** As per above dimensions
- Artwork resolution:** 300 dpi (minimum)
- Artwork file type:** *Print-ready PDFs, supplied as separate pages
- Other requirements:** • 3 mm bleed around all edges • Crop marks • All fonts embedded • CMYK • No spot colours.

****NOTES:** CN Magazine is perfect bound, which means that there is a spine. Following our printer's advice, we advise that you avoid placing text/key information 10 mm (width) either side of the spine.

Front cover fold-out visual

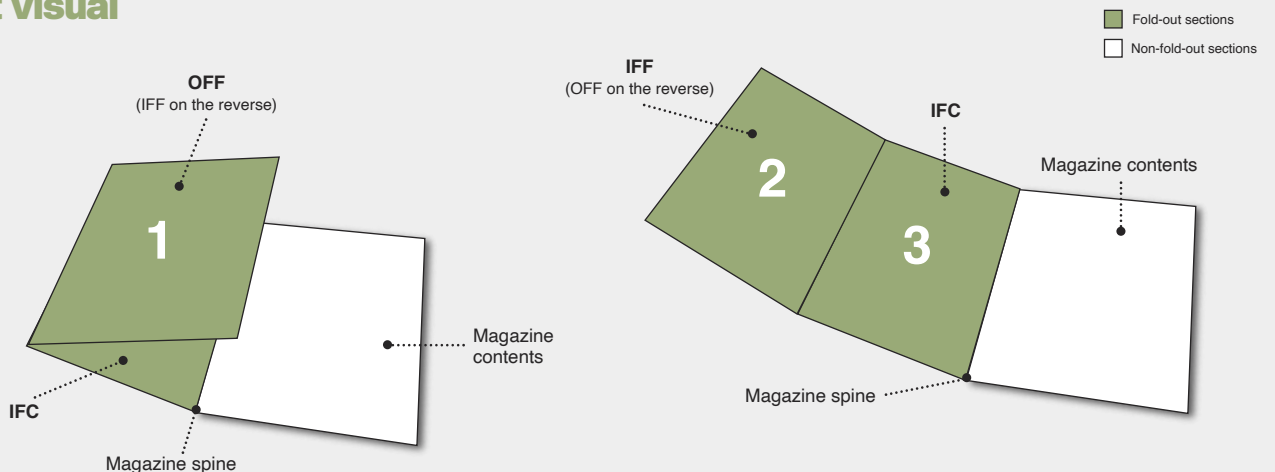

Back cover fold-out (4-pages)

Inside back cover (IBC):

209 mm (w) x 297 mm (h)*

Inside back fold-out (IBF):

199 mm (w) x 297 mm (h)*

Outside back fold-out (OBF):

199 mm (w) x 297 mm (h)*

Outside back cover (OBC):

209 mm (w) x 297 mm (h)*

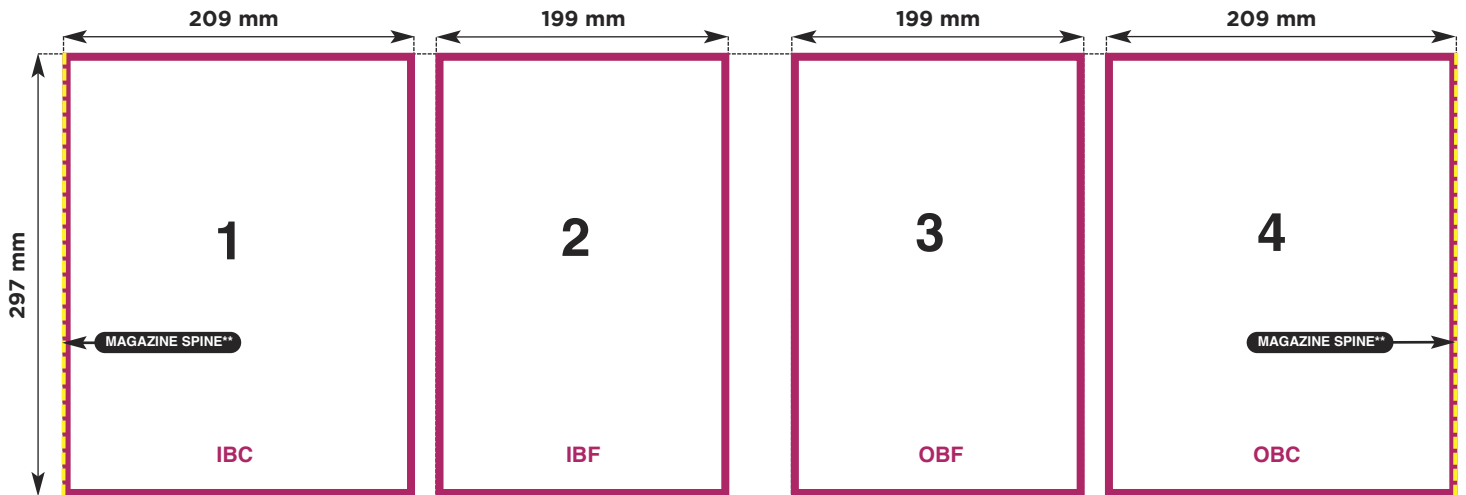

Artwork requirements:

Artwork size: As per above dimensions

Artwork resolution: 300 dpi (minimum)

Artwork file type: *Print-ready PDFs, supplied as separate pages/sections

Other requirements: • 3 mm bleed around all edges • Crop marks • All fonts embedded • CMYK • No spot colours.

****NOTES:** CN Magazine is perfect bound, which means that there is a spine. Following our printer's advice, we advise that you avoid placing text/key information 10 mm (width) either side of the spine.

Back cover fold-out visual

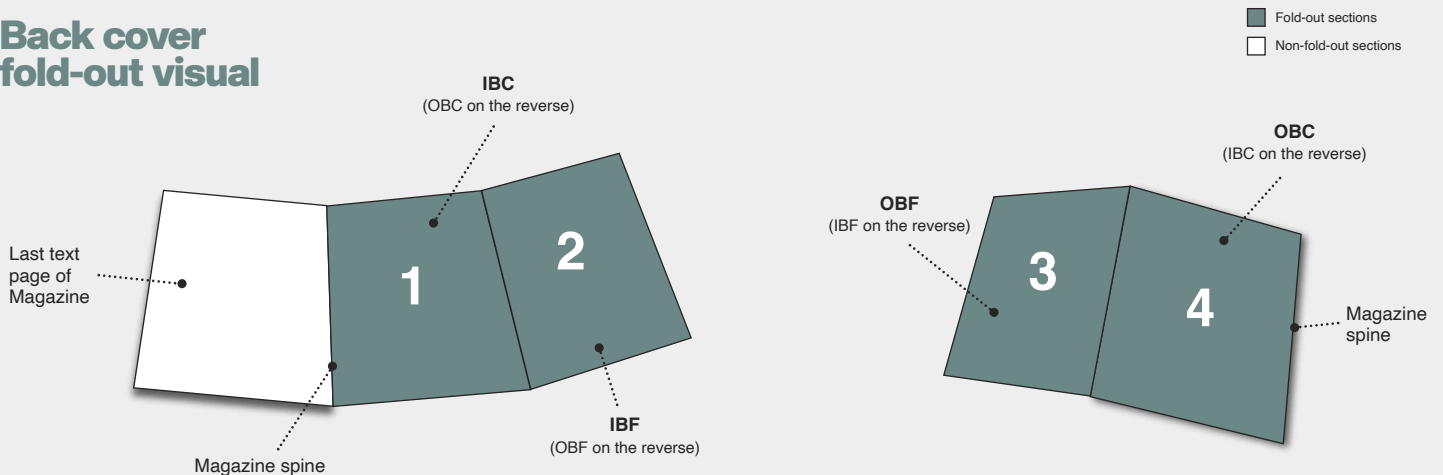

Internal fold-out (4-pages)

Internal page front (IPF):

209 mm (w) x 297 mm (h)*

Front fold-out (FFO):

199 mm (w) x 297 mm (h)*

Back fold-out (BFO):

199 mm (w) x 297 mm (h)*

Internal page back (IPB):

209 mm (w) x 297 mm (h)*

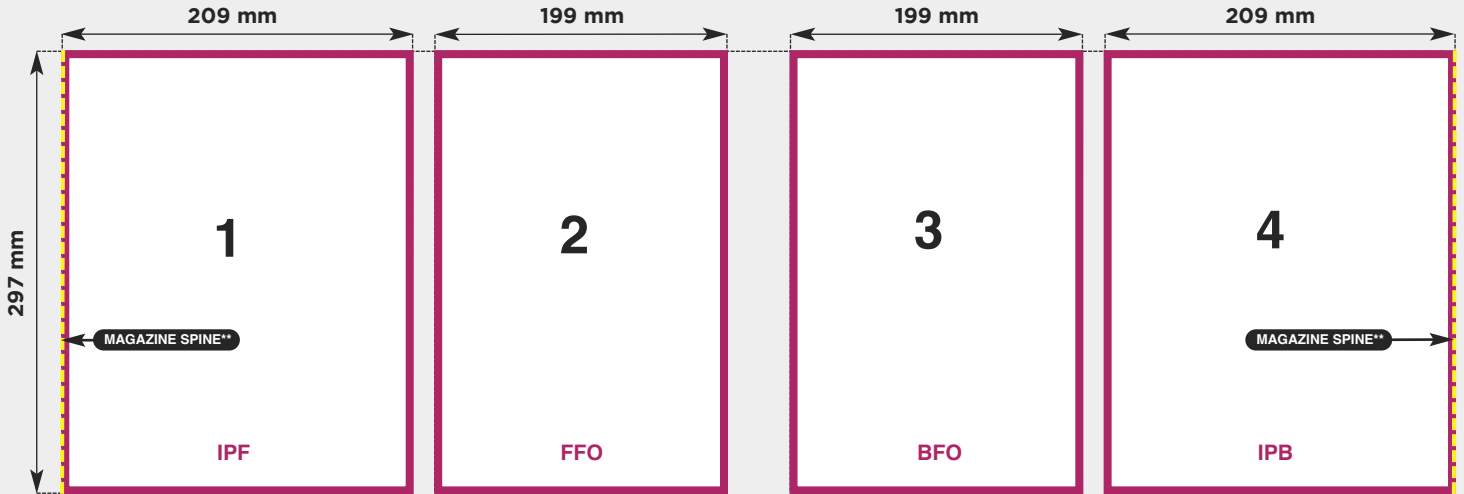

Artwork requirements:

Artwork size: As per above dimensions

Artwork resolution: 300 dpi (minimum)

Artwork file type: *Print-ready PDFs, supplied as separate pages

Other requirements: • 3 mm bleed around all edges • Crop marks • All fonts embedded • CMYK • No spot colours.

****NOTES:** CN Magazine is perfect bound, which means that there is a spine. Following our printer's advice, we advise that you avoid placing text/key information 10 mm (width) either side of the spine. The fold-out will be produced on a thicker stock (150 gsm) than the rest of the internal pages (100 gsm).

Internal fold-out visual

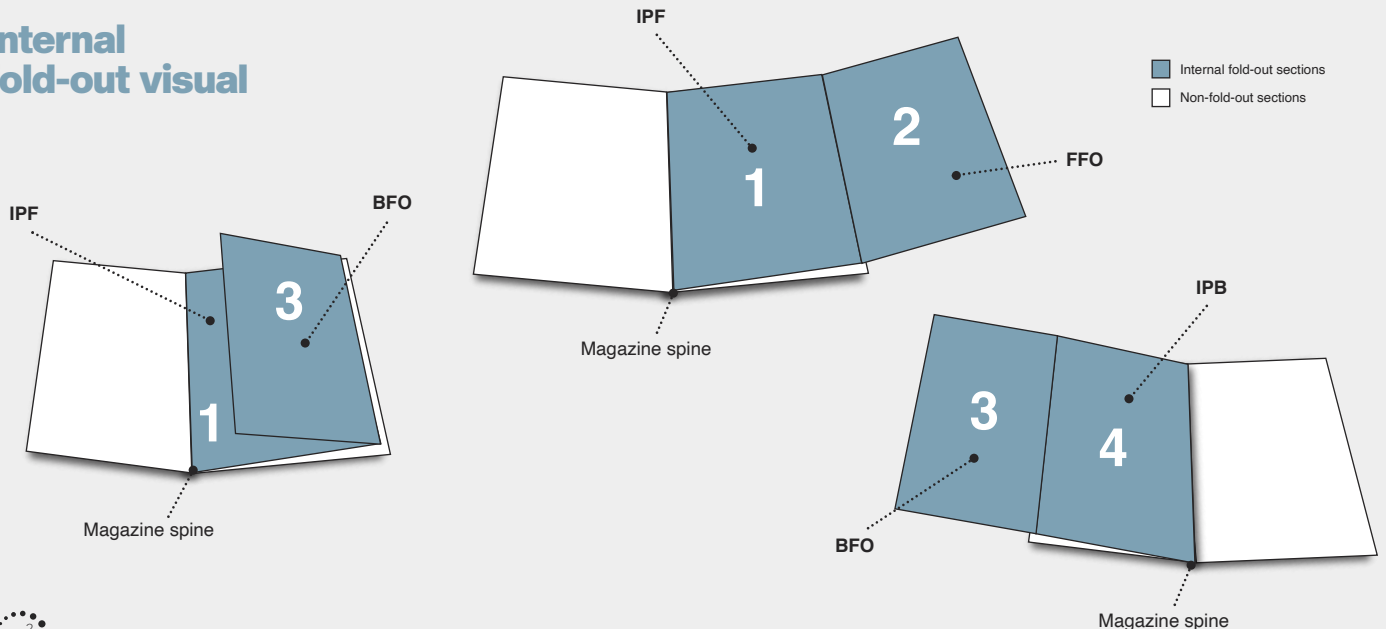

Barndoor

Inside:

208 mm (w) x 297 mm (h)

Left & right barndoor:

104 mm (w) x 297 mm (h)

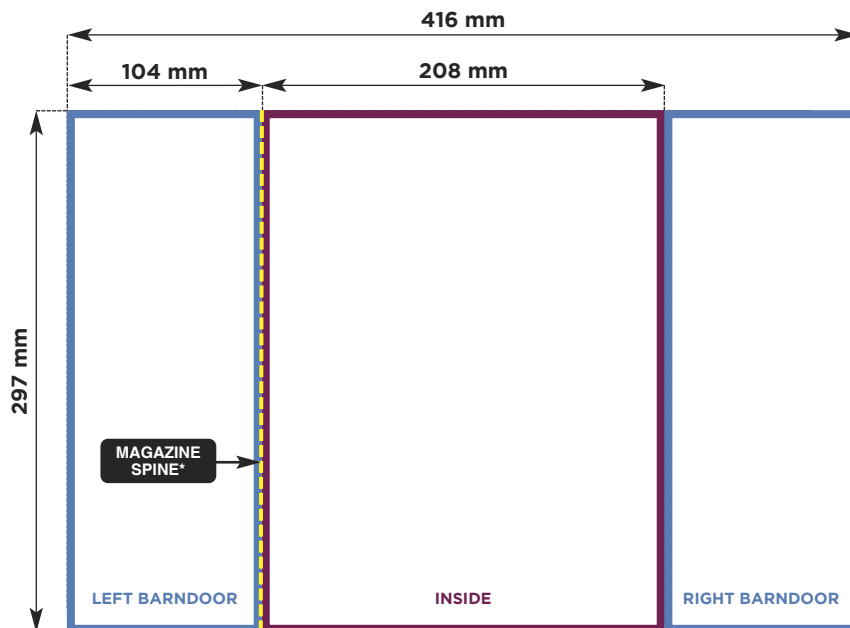

Artwork requirements:

- Artwork size:** As per above dimensions
- Artwork resolution:** 300 dpi (minimum)
- Artwork file type:** Print-ready PDFs, supplied as separate pages/sections
- Other requirements:** • 3 mm bleed around all edges • Crop marks • All fonts embedded • CMYK • No spot colours.

***NOTES:** CN Magazine is perfect bound, which means that there is a spine. Following our printer's advice, we advise that you avoid placing text/key information 10 mm (width) either side of the spine.

Barndoor visual

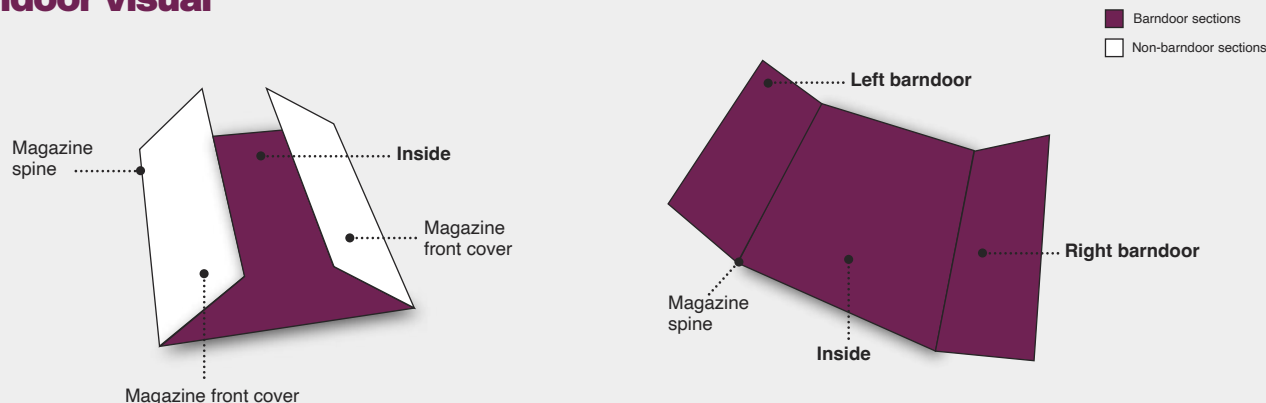

False cover

Page sizes

210 mm (w) x 297 mm (h)

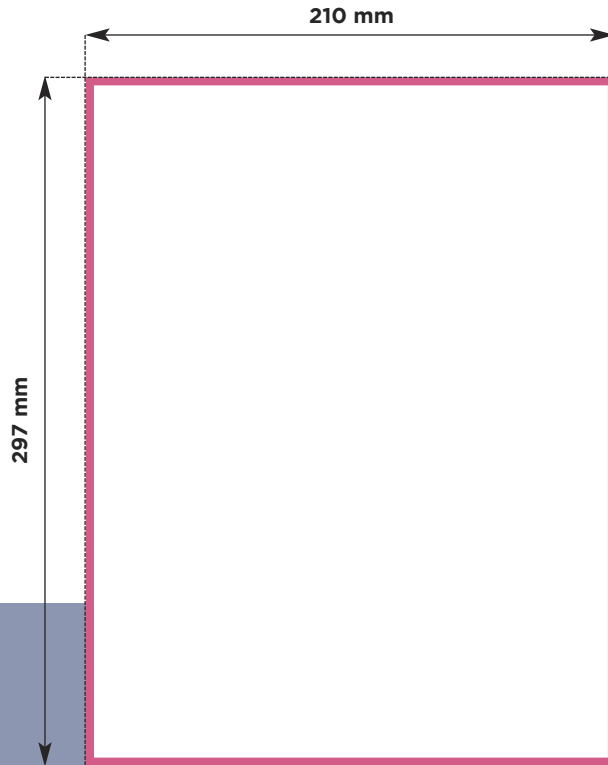

Artwork requirements:

- Artwork size:** As per above dimensions
- Artwork resolution:** 300 dpi (minimum)
- Artwork file type:** Print-ready PDFs, supplied as separate pages
- Other requirements:** • 3 mm bleed around all edges • Crop marks • All fonts embedded • CMYK • No spot colours.

***NOTES:** The CN logo and issue details need to be displayed on your false cover. Please request these details and artwork at the time of booking.

CN Magazine is perfect bound, which means that there is a spine. Following our printer's advice, we advise that you avoid placing text/key information 10 mm (width) either side of the spine.

False cover visual

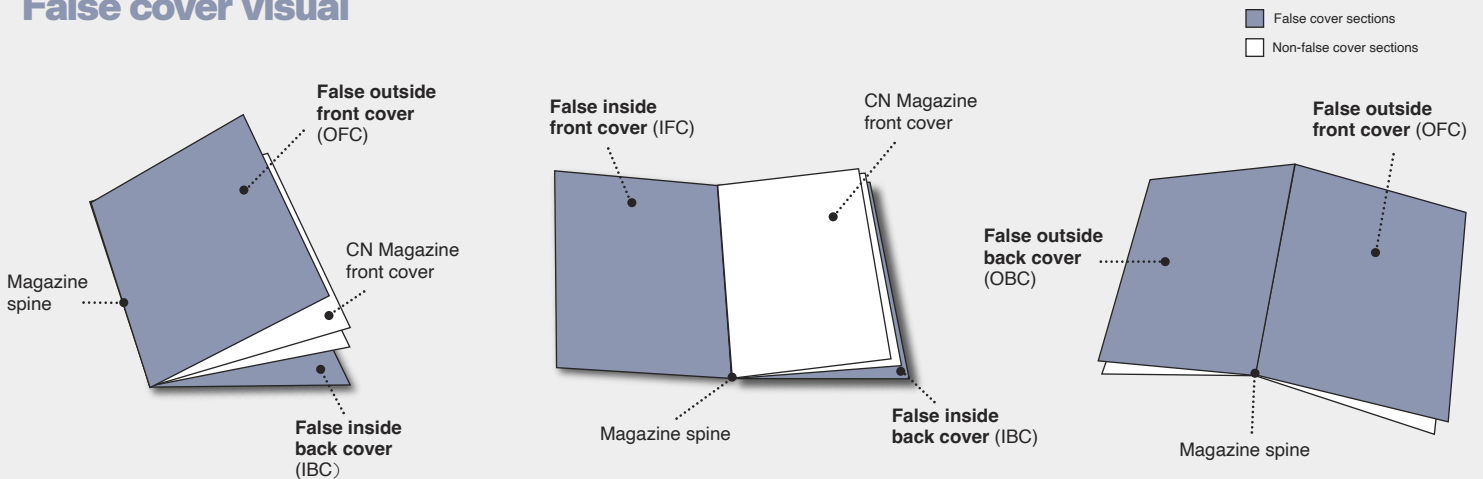

nutrition2me.com

Homepage

Leaderboard: 728 px (w) x 90 px (h)

Premium single MPU: 300 px (w) x 250 px (h)

Premium double MPU: 600 px (w) x 250 px (h)

Premium quadruple MPU: 1,230 px (w) x 250 px (h)

Single MPU: 300 px (w) x 250 px (h)

Double MPU: 600 px (w) x 250 px (h)

Quadruple MPU: 1,230 px (w) x 250 px (h)

3rd row single MPU: 300 px (w) x 250 px (h)

3rd row double MPU: 600 px (w) x 250 px (h)

3rd row quadruple MPU: 1,230 px (w) x 250 px (h)

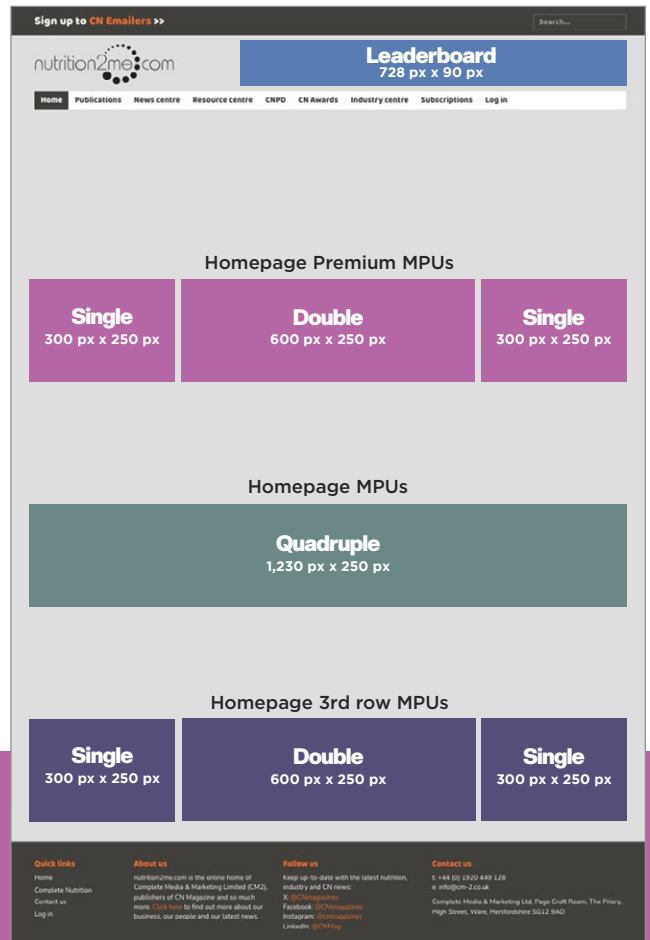

Artwork requirements:

Artwork size: As per above dimensions

Artwork resolution: 72 dpi

Artwork file type: RGB JPEG (static), GIF (animated) and 3rd party (click tag JavaScript)

Other requirements: Please supply the URL link you would like the banner to link to if supplying a JPEG or GIF.

Important notes:

- Some animated files may differ when viewed in different browsers
- **Static artwork:** Recommended file size range is 200 KB to 700 KB
- **Animated artwork:** Recommended file size range is 200 KB to 850 KB. Please ensure that all animated artwork is set to a continuous loop.
- **Rich media:** If supplying rich media file(s), maximum video length is 20 seconds, and should be set to a continuous loop and not expandable. Flash files not accepted.
- **Responsive artwork:** If you require your artwork to be responsive, then it is your responsibility to supply the artwork as so.

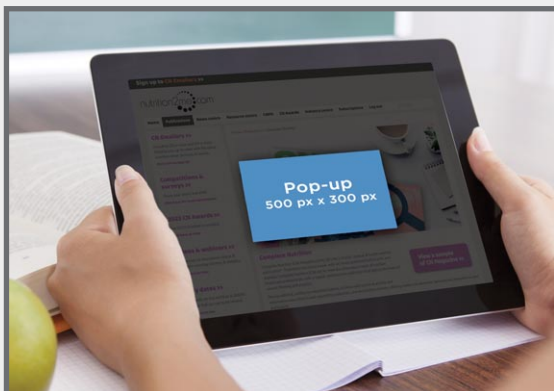

Pop-up

- **Artwork size:** 500 px (w) x 300 px (h)
- **Artwork resolution:** 72 dpi
- **Artwork file type:** JPEG (static) or GIF (animated)
- **Other requirements:** Please supply the URL link you would like the pop-up to link to.

nutrition2me.com

Sidebar banners

Sidebar MPU:

300 px (w) x 250 px (h)

Sidebar vertical double MPU:

300 px (w) x 600 px (h)

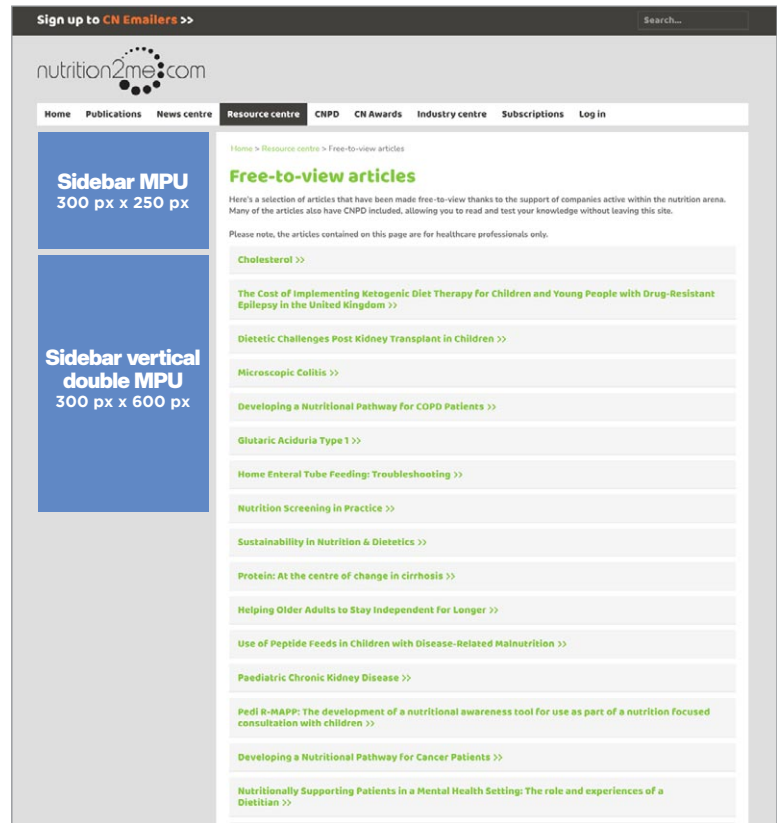

Artwork requirements:

- Artwork size:** As per above dimensions
- Artwork resolution:** 72 dpi
- Artwork file type:** RGB JPEG (static), GIF (animated) and 3rd party (click tag JavaScript)
- Other requirements:** Please supply the URL link you would like the banner to link to if supplying a JPEG or GIF.

Important notes:

- Some animated files may differ when viewed in different browsers
- **Static artwork:** Recommended file size range is 200 KB to 700 KB
- **Animated artwork:** Recommended file size range is 200 KB to 850 KB. Please ensure that all animated artwork is set to a continuous loop.
- **Rich media:** If supplying rich media file(s), maximum video length is 20 seconds, and should be set to a continuous loop and not expandable. Flash files not accepted.
- **Responsive artwork:** If you require your artwork to be responsive, then it is your responsibility to supply the artwork as so.

Videos & webinars

Please supply as follows:

- **Logo:** High-resolution JPEG or PNG
- **Video/webinar title & description of video:** Please include an introduction paragraph, plus details of who is featured in the video/webinar if applicable, in a Word document (50-100 words).
- **The video file:** Please supply a link to embed (e.g. You Tube), MP4 or MOV – maximum recommended file size is 60 MB*

* Larger files can be supplied but will be reduced at our end for uploading



CN eXtra

We recommend around 500-600 words, a logo, plus a couple of images/embedded videos. Please supply as follows:

- **Logo/images:** As high-resolution JPEGs or PNGs
- **Text:** As a Word document
- **Video files:** Supplied as a link to embed (e.g. You Tube), MP4 or MOV – maximum recommended file size is 60 MB*

* Larger files can be supplied but will be reduced at our end for uploading

Diary dates

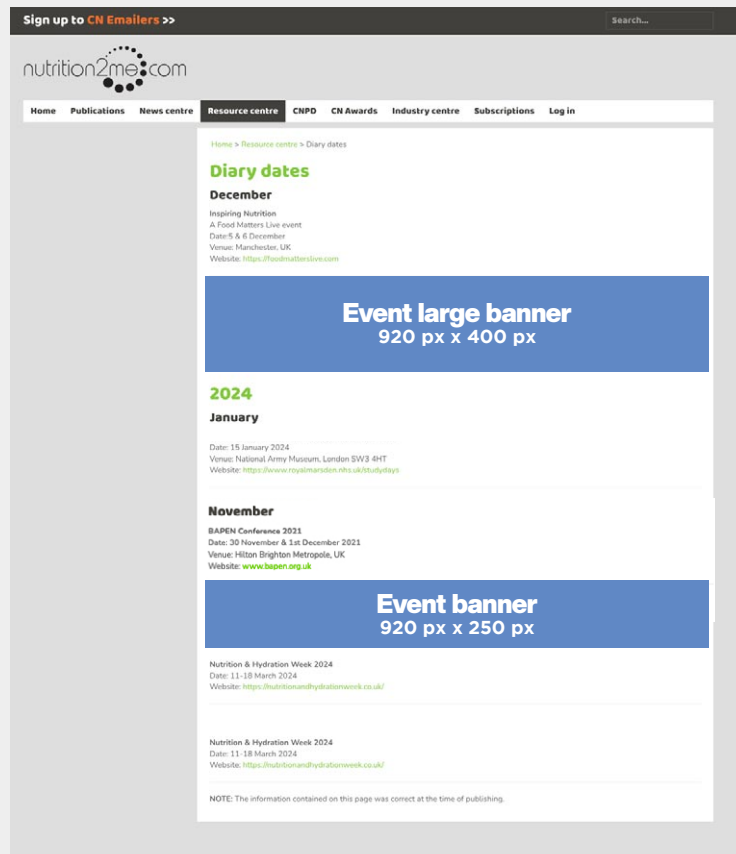

Event listing with logo

Please supply:

- A logo
- Event title
- Event description linage
- Date
- Website
- Email
- Tel

Copy requirements: Please supply logo as a high-resolution JPEG or PNG file. All text should be supplied in a Word document.

Event banners

- **Large banner:** 920 px (w) x 400 px (h)
- **Banner:** 920 px (w) x 250 px (h)

Artwork requirements: Static JPEG or animated GIF, plus URL link supplied for both.

Notes:

- Some animated files may differ when viewed in different browsers
- Static artwork: Recommended file size range is 200-500 KB
- Animated artwork: Recommended file size range is 200-750 KB. Please ensure that all animated artwork is set to a continuous loop.



nutrition2me.com

Paediatric focus banners

Leaderboard:

728 px (w) x 90 px (h)

Sidebar MPU:

300 px (w) x 250 px (h)

Sidebar vertical double MPU:

300 px (w) x 600 px (h)



Artwork requirements:

Artwork size: As per above dimensions

Artwork resolution: 72 dpi

Artwork file type: RGB JPEG (static), GIF (animated) and 3rd party (click tag JavaScript)

Other requirements: Please state the URL link you would like the banner to link to if supplying a JPEG or GIF.

Important notes:

- Some animated files may differ when viewed in different browsers
- **Static artwork:** Recommended file size range is 200 KB to 700 KB
- **Animated artwork:** Recommended file size range is 200 KB to 850 KB. Please ensure that all animated artwork is set to a continuous loop.
- **Rich media:** If supplying rich media file(s), maximum video length is 20 seconds, and should be set to a continuous loop and not expandable. Flash files not accepted.
- **Responsive artwork:** If you require your artwork to be responsive, then it is your responsibility to supply the artwork as so.

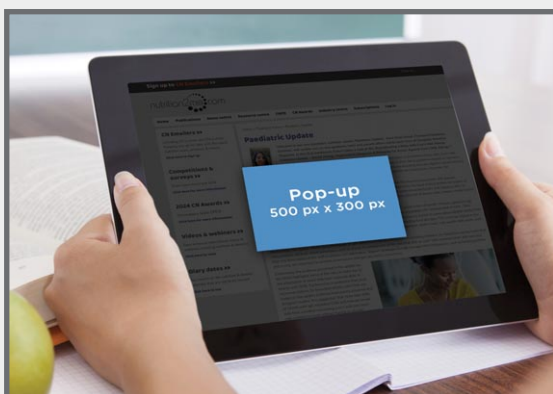

Paediatric focus Pop-up

- **Artwork size:** 500 px (w) x 300 px (h)
- **Artwork resolution:** 72 dpi
- **Artwork file type:** JPEG (static) or GIF (animated)
- **Other requirements:** Please supply the URL link you would like the pop-up to link to.

Digital issue banners

Banner 1

- **Artwork size:**
900 px (w) x 900 px (h)
- **Artwork resolution:**
72 dpi
- **Artwork file type:**
JPEG (static) or GIF (animated)
- **Other requirements:**
Please supply a separate URL link for JPEG and GIF files.

Figure 1 - Banner 1 & 2 in FULL SCREEN display

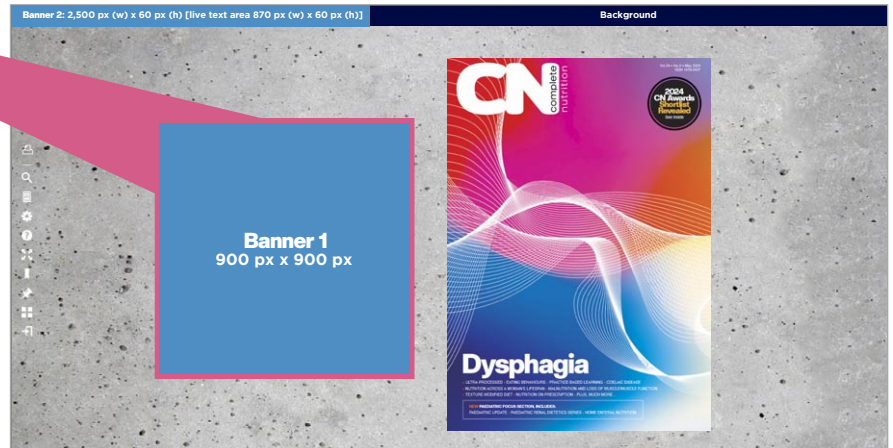

Banner 2

- **Artwork size:**
2,500 px* (w) x 60 px (h)
- **Artwork resolution:**
72 dpi
- **Artwork file type:**
JPEG (static) or GIF (animated)
- **Other requirements:**
Please supply a separate URL link for JPEG and GIF files.

Figure 2 - Banner 2 'live text' display area*

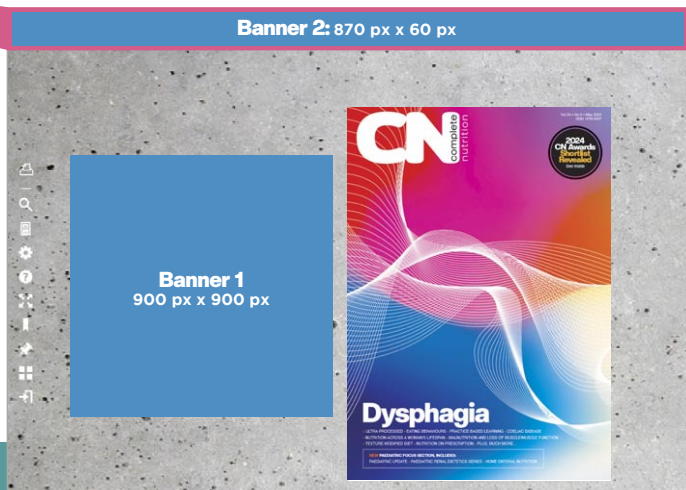

Important notes:

- All banner artwork should be aligned left, as the banner is cropped from the right on smaller displays (see Figure 1 & 2)
- *Banner 2's full width is 2,500 px, this is made up of a live text area and background. The maximum 'live text' area width of your banner should be 870 px (w) (see Figure 2), and the background should form a continuous design to the maximum of 2,500 px (w) to fill the space when viewed in full screen mode (see Figure 1).
- Banner 1 & 2 artwork will not display on smartphones due to the limited screen space.
- Banners may display differently when viewed on different browsers and brands of tablets.

Digital issue emailer banner**

- **Artwork size:** 600 px (w) x 250 px (h)
- **Artwork resolution:** 72 dpi
- **Artwork file type:** JPEG
- **Other requirements:** Please supply a separate URL link for the banner

**The digital issue emailer banner can only be purchased as an add-on in conjunction with the digital issue sponsorship booking.



CN e-shots

Artwork requirements:

- **Artwork resolution:** 600 px (w) x 1,500 px (h)
(recommended maximum height*)
- **Artwork resolution:** 300 dpi (minimum)
- **Artwork file type:** JPEG (RGB)

Subject line recommendations:**

- A great subject line gives your audience a reason to open your e-shot!
- Where possible, please limit subject lines to fewer than 9 words – 60 characters in total
- Please avoid using emojis and special characters
- Limit punctuation marks to 3 or less.

Other requirements:

- One URL link to be supplied (your e-shot will link directly to this URL)
- Only static files accepted, as animated files are not supported by all email platforms
- Minimum recommended text size 6pt.

Social sharing image:

We socially share CN e-shots via Facebook and X (unless you have opted out†). We use a generic 'CN e-shot' image when sharing on Facebook and X, although, if you wish to provide your own image†† for social sharing, please provide to the following spec:

- **Artwork size:** 550 px (w) x 330 px (h)
- **Artwork resolution:** 300 dpi (minimum)
- **Artwork file type:** JPEG (RGB).

* If your Artwork is supplied over our recommended max height (1,500 pixels [h]) you will have to supply the artwork in 2 sections.

** These recommendations are provided as guidance only to help CN e-shots perform at their best and avoid junk and spam filters.

† All CN e-shots are automatically socially shared across CN's X and Facebook accounts. If you do not want your CN e-shot to be socially shared, you must opt out at the time of booking. Any CN e-shot relating to infant formula will not be socially shared.

†† The image supplied must relate directly to the CN e-shot.

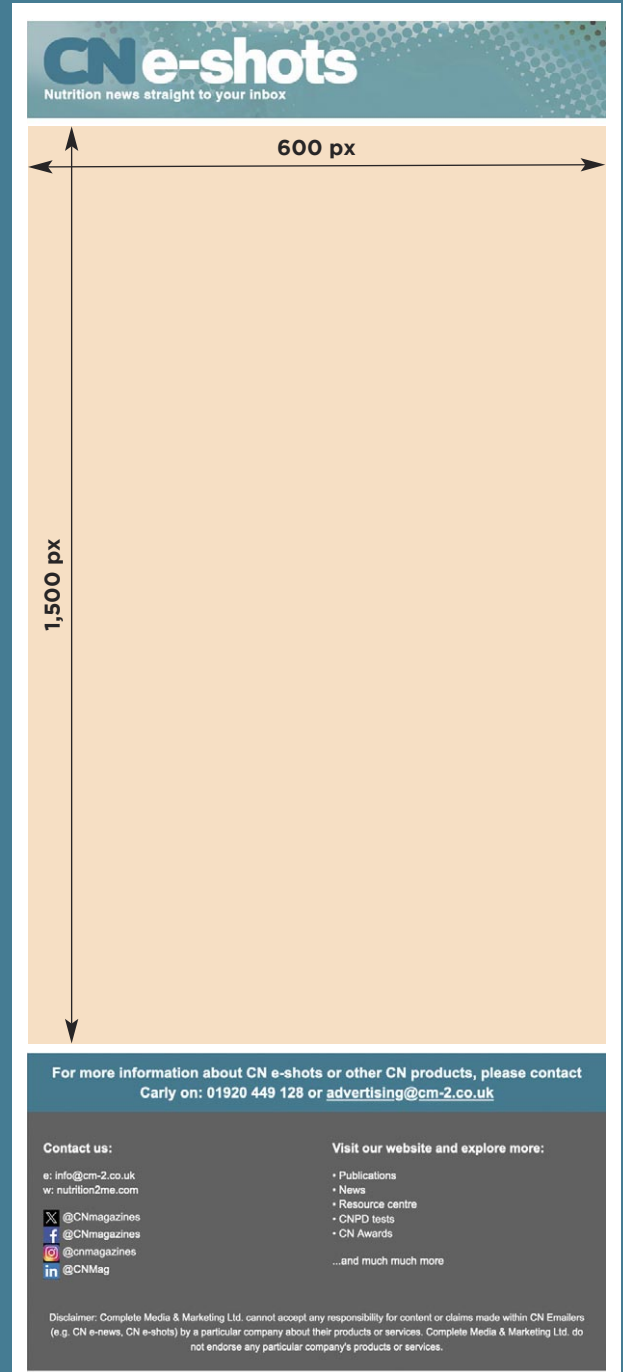

CN e-shot design service

Require artwork design and layout? For a quote please contact: advertising@cm-2.co.uk

CN e-news

Leaderboard & banners:

- **Artwork size:** 630 px (w) x 140 px (h)*
- **Artwork resolution:** 72 dpi**
- **Artwork file type:** RGB JPEG***
- **Other requirements:** Please supply a URL link for your banner.

*We recommend adding a small keyline boarder around banners with white backgrounds.

**Minimum recommended text size: 6pt.

***Only static files accepted, as animated files are not supported by all email platforms.

Product/Event/Resource/Job/Webinar of the Month:

- **Includes:** 1 image plus max 250 words
- **Image:** High-resolution JPEG – minimum 300 dpi
- **Text:** To be supplied within a Word document

CNe-news
A twice-monthly e-newsletter for nutrition healthcare professionals

Leaderboard

630 px x 140 px

Welcome

Welcome to CN e-news, the twice-monthly e-newsletter delivering the latest nutrition & CN news to your inbox!

Nominations for the 2024 CN Awards are OPEN! Do you know someone that's made a difference? An individual that's gone above and beyond? Or, perhaps, an organisation that has developed a resource or guidance that has improved patient care?

See the CN Awards section below for further information on how to make a nomination and to enter our prize draw for the chance to WIN a £250 voucher of your choice!

With best wishes,
The CN Team

Article of the Month

Glutaric Aciduria Type 1

You can read the article in your November issue of CN Magazine.

You can also take the CNPD quiz for this article. Unlike other CPD services, CNPD is completely free to use, auto-marks you as you take the test, and even emails your results direct to your inbox, ready to print off and file.



Premium banner

630 px x 140 px

Product of the Month

From July 2023: There was a change to the iron levels in SMA Gold Prem® 2 Post discharge feed.

The level of iron has changed to 1.2 mg/100 ml (1.6 mg/100 kcal) for both powder and liquid formulations.

No significant changes have been made to other key ingredients.

Please amend your preterm iron supplementation guidelines accordingly.



News & Views

Read all about it!

- Aston University Research Identifies Four Eating Behaviour Patterns in Children
- Can a healthier diet be the answer to managing menopause symptoms?
- Practicing Mindfulness Can Help People Make Healthier Eating Choices
- Red Meat Consumption Associated with Increased Type 2 Diabetes Risk



Banners

630 px x 140 px

Webinar of the Month

Non-Sugar Sweeteners: Balancing the Debate

This webinar, led by registered dietitians Dr. Paul McArdle and Nichola Ludlam-Raine, provides an insightful overview of the safety of non-sugar sweeteners.

The discussion delves into several key areas related to non-sugar sweeteners, addressing prevalent misconceptions and misleading media headlines surrounding them such as impact on blood glucose levels, potential for weight gain and carcinogenic risks.

During the session, Dr. Paul McArdle and Nichola Ludlam-Raine will also address queries from other healthcare professionals regarding non-sugar sweeteners.



CN's Resource Centre

Information & resources to help you in your day-to-day practice

This Resource Centre at www.nutrition2me.com has been created to provide you with a central point to access a variety of information, including: Diary dates, Journal watch, Videos & webinars, Free-to-view articles, plus much more.

We've recently added the following articles to our Free-to-view section:

- Sustainability in Nutrition & Dietetics
- Nutrition Screening in Practice



For more information about CN e-news or other CN products, please contact Cary on: 01920 449 128 or email: advertising@cm-2.co.uk

Contact us:

e: info@cm-2.co.uk
w: nutrition2me.com

Visit our website and explore more:

- Publications
- News
- Resource centre
- CNPD tests
- CN Awards
- ...and much much more

[X](#) @CNmagazines
[f](#) @CNmagazines
[i](#) @cmagazines
[in](#) @CNMag

Disclaimer: Complete Media & Marketing Ltd. cannot accept any responsibility for content or claims made within CN Enews (e.g. CN e-news, CN e-shots) by a particular company about their products or services. Complete Media & Marketing Ltd. do not endorse any particular company's products or services.

Note: This is a visual representation only and CN e-news may differ in appearance when sent.

Social media sponsorship



Facebook

Artwork specifications

- **Artwork size:**
1,000 px (w) x 1,000 px (h)
- **Artwork resolution:**
72 dpi
- **Artwork file type:**
JPEG or PNG

Text specifications

- **Character limit:**
1,000 characters (including hashtags, spacing and URLs)
- **Text:**
All text to be supplied in a Word document



X

Artwork specifications

- **Artwork size:**
1,000 px (w) x 1,000 px (h)
- **Artwork resolution:**
72 dpi
- **Artwork file type:**
JPEG or PNG

Text specifications

- **Character limit:**
240 characters (including hashtags, spacing and URLs)
- **Text:**
All text to be supplied in a Word document



Instagram

Artwork specifications

- **Artwork size:**
1,000 px (w) x 1,000 px (h)
- **Artwork resolution:**
72 dpi
- **Artwork file type:**
JPEG or PNG

Text specifications

- **Character limit:**
1,000 characters (including hashtags, spacing and URLs)
- **Text:**
All text to be supplied in a Word document

Social media POST

Please note: **One** image and **one** piece of text to be provided, which will be shared across all three social media platforms at the same time and date. Date of post can be selected from a **4-week period.**

Social media BUNDLE

Please note: Up to **three** images and **three** pieces of text can be provided (maximum of three posts in total):

- **Post 1:** shared across our three social media platforms at the same time and date*
- **Post 2:** shared across our three social media platforms at the same time and date*
- **Post 3:** shared across our three social media platforms at the same time and date*

All images and text must be supplied at the same time by the copy deadline set at time of booking. Dates can be selected across a **6-week period.**

*Subject to availability. Posted between 08:00 & 18:00 hrs. Excludes weekends and bank holidays.